



Powered by  **GREE**



Model No. SG-PAC-10E5
Reference No. KY-100E5
10,000 BTU Portable Air Conditioner
Operating Instructions

V.121016

Thank you for choosing a Soleus Air Powered by Gree Portable Air Conditioner. This owner's manual will provide you with valuable information necessary for the proper care and maintenance of your new product. Please take a few moments to thoroughly read the instructions and familiarize yourself with all the operational aspects of your new Portable Air Conditioner.

For your own records, please attach a copy of your sales receipt to this manual. Also, write the store name/location, date purchased, and serial number below:

Store Name: _____

Location: _____

Date Purchased: _____

Serial Number (located on back of unit): _____

IMPORTANT INSTRUCTIONS

Before installing and using your portable air conditioner, please read this owner's manual carefully. Store this manual in a safe place for future reference.

- 1) Always place the unit on a level surface.
- 2) Never use or store gasoline or other flammable vapor or liquid near this unit unless instructed by this manual.
- 3) Maintain at least 10 inches (25 cm) clearance space around this unit. Do not block or cover air inlet or outlet grilles.
- 4) The unit must be connected to a correctly grounded power supply.
- 5) Do not start or stop the unit by inserting or pulling out the power plug.
- 6) Do not use an adapter plug or extension cord.
- 7) Do not use the unit in the immediate surroundings of a bath, a shower or a swimming pool.
- 8) Do not insert anything into the air outlet. Do not obstruct air inlet or outlet grills unless instructed by this manual.
- 9) Do not let children play near this unit.
- 10) Always inspect the cord for signs of damage before use. If the power cord is damaged, it must be replaced by the manufacturer or a qualified service technician.
- 11) When cleaning the unit, always turn the unit off and unplug the power cord.
- 12) Do Not Mix Old And New Batteries. Do Not Mix Alkaline, Standard (Carbon - Zinc), Or Rechargeable (Nickel - Cadmium) Batteries.

PACKAGE CONTENTS

Portable Air Conditioner
Exhaust Hose (1)
Exhaust Hose Adapter (1)
Window Kit Adapter (1)
Hose Adapter (1)
Remote Control & AAA Batteries (2 batteries)
Window Kit - 3 Sliding Panels (1 single hose panel, 2 extension panels)
Drain Hose Assembly (drain pipe, clamp, hose clip, rubber plug, & screw)
Owner's Manual

SPECIFICATIONS

- The cooling capacity is measured at an ambient temperature of DB 86 °F, WB 78 °F.
- Noise level is measured at a distance of 3.28 ft away from the front of the unit, when the unit is in cooling mode.
- Power consumption is measured when the fan runs at the highest speed setting.
- These specifications are for reference only. For actual data, please refer to the rating label on the back of the unit.
- If the environment temperature is higher than the max operating temperature or lower than the minimum operating temperature, the air conditioner may not work properly.

Model No. / Reference No.	SG-PAC-10E5 / KY-100E5
Power Supply (Ph/V/Hz)	1/115/60Hz
Dehumidifying Capacity (Pints/Day)	50
Rated Cooling Capacity (BTU/h)	10,000
Rated Heating Capacity (BTU/h)	/
Cooling Power Input (Watts)	1070
Heating Power Input (Watts)	/
Rated Current Cooling (Amperage)	9.5
Rated Current Heating (Amperage)	/
Noise Level dB(A)	<=56
Air Flow - H / M / L	195 / 165 / 135 CFM
Product Dimensions (W" x D" x H")	11.75 x 14.75 x 31.75
Product Weight (Lbs)	55
Refrigerant Type	R-410A
Refrigerant Charge (Oz)	15.1

LCDI POWER CORD AND PLUG

This air conditioner is equipped with an LCDI (Leakage Current Detection and Interruption) power cord and plug as required by US National Electric Code 440.65. This cord consists of a length of shielded flexible cord with no termination on the load side and a LCDI attachment plug on the line side.

The LCDI power cord and plug will remove the supply source via electrical disconnect (circuit trip) if the nominal current leakage between the cord shield and either load conductor exceeds a predetermined value. The cord will remain de-energized until the device has been manually reset. This is intended to reduce the risk of a fire in the power cord or combustible materials nearby. The cord shields are not grounded and they must be considered a shock hazards if exposed. The cord shield must not be connected to ground or to any exposed metal.

The test and reset buttons on the LCDI Plug are used to check if the plug is functioning properly. To test:

1. Plug power cord into wall outlet
2. Press TEST Button, circuit should trip, cutting power to the air conditioner
3. Press RESET button for use

If a test is performed and the indicator light remains ON, current leakage has been detected. Do not use the air conditioner or attempt to reset the LCDI Plug. Contact Soleus Air Powered by Gree Customer Service for troubleshooting recommendations.

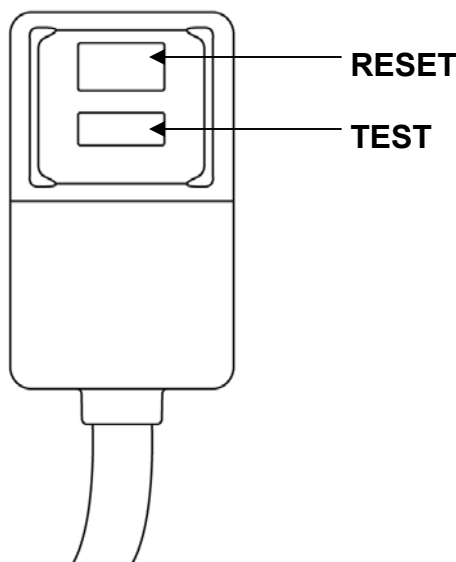

WARNING:

1. DO NOT press the TEST button while the air conditioner is operating.
2. The TEST and RESET buttons should not be used as “ON” and “OFF” switches.
3. The cord and plug are not intended to offer protection to externally connected loads or supply circuits.
4. The cord and plug are intended for indoor use only.

NOTE: Your units power cord and plug may differ from the one shown.

PRODUCT DIAGRAM

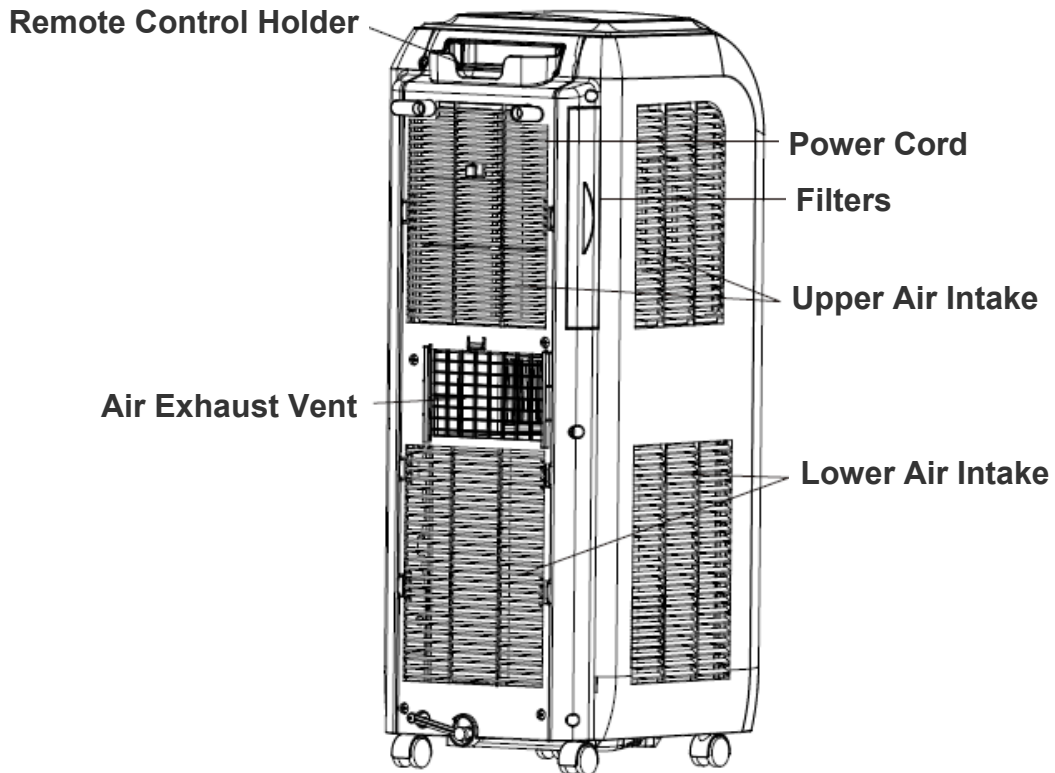
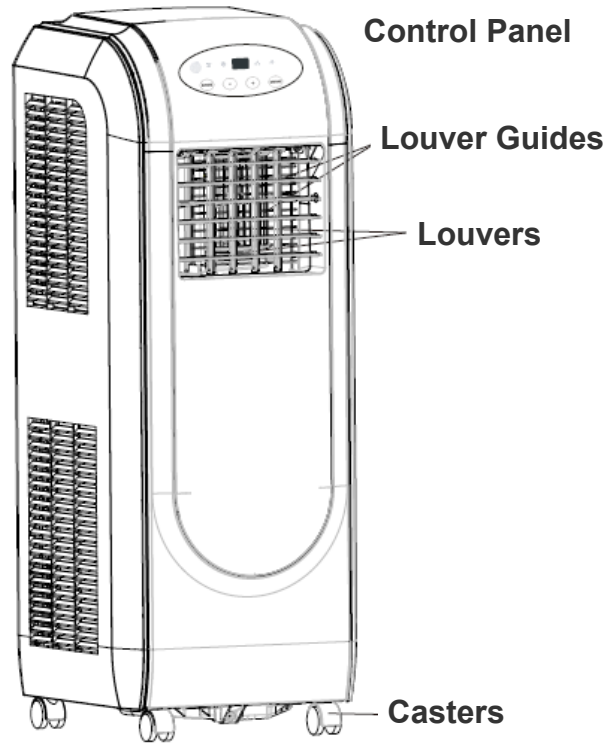

PARTS & WINDOW KIT ASSEMBLY

PARTS

EXHAUST HOSE & ADAPTERS

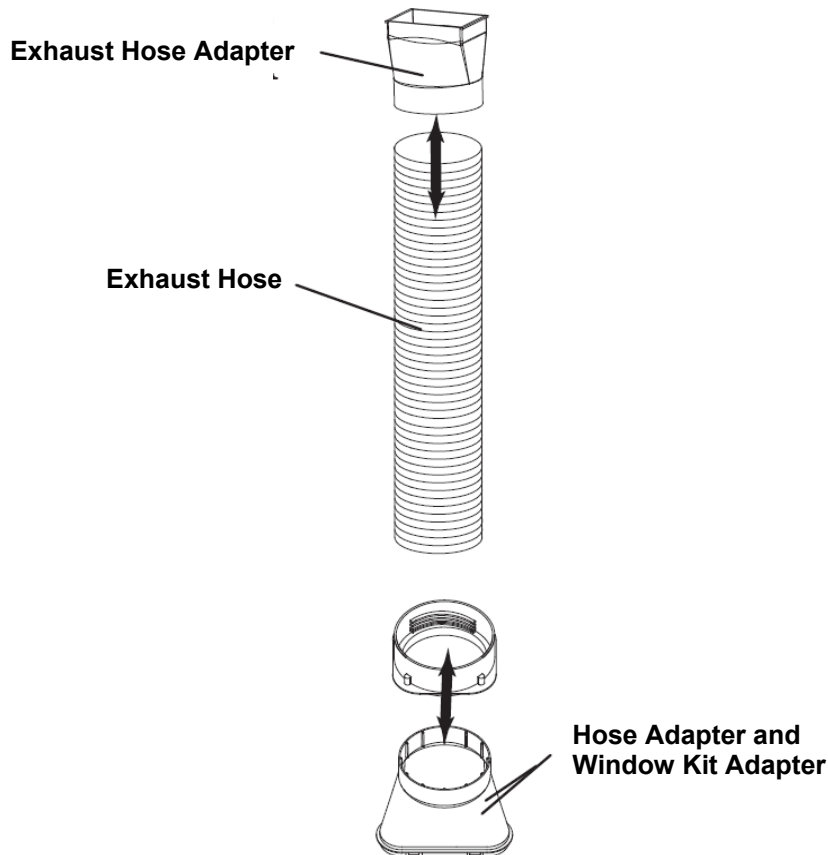

ASSEMBLY & INSTALLATION

INSTALLATION

When the unit is operating as an air conditioner or dehumidifier, the window kit and exhaust hose must be installed. When the unit is operating in fan mode, the window kit and exhaust hose do not need to be installed .

MOUNTING THE EXHAUST HOSE

- Choose a suitable location, near a grounded electrical outlet and suitable window or door. Remove packaging and locate components.
- Extend both ends of the exhaust hose approximately 6 inches.
- Screw the window kit adapter onto one end of the exhaust hose clockwise. Screw the hose adapter onto the other end of the exhaust hose clockwise.
- Mount the exhaust hose onto the back of the unit by locking the hose adapters into place.
- For maximum efficiency do not bend the hose as much as possible.

SINGLE HOSE WINDOW KIT INSTALLATION

Installation of the Venting Kit FOR SINGLE HOSE PORTABLE AIR CONDITIONERS

Innovative products for a cleaner,
more comfortable world.



The venting kit must be installed in order for the unit to work correctly in the air conditioning mode. The venting kit should not be used while the unit is heating or fanning.

The window kit has been designed to fit into most vertical and horizontal window openings. The window kit can also be used in a sliding door.

1. Choose a suitable location, near a grounded electrical outlet and a suitable window or door. Remove packaging and locate components. (figure a)
2. Slide the exhaust connector over the discharge opening on the back of the unit. (figure b)
3. Connect the exhaust hose to the exhaust connector, aligning the fitted groove. (figure c)
4. Open the window or door and adjust the length of the window kit to fit the opening. (figure d) If necessary, mark the kit and cut one end down to properly fit the opening. (figures e & f)
5. Attach the window kit adapter to the window kit. (figure g)
6. Place the window kit back into the window and attach the exhaust hose to the window kit adapter. (figures h & i) Close the window tightly. (figure j) Your Portable Air Conditioner is now ready to cool!

NOTE: When using the venting system, keep the exhaust hose as straight as possible. The exhaust hose can be shortened, but it is not recommended to increase the length of the exhaust hose. Do not use an extension cord with your portable air conditioner.

This installation is OK

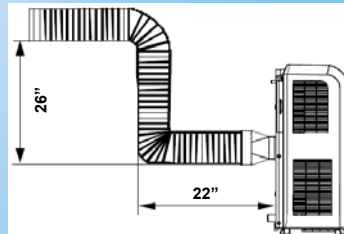

The is a poor installation

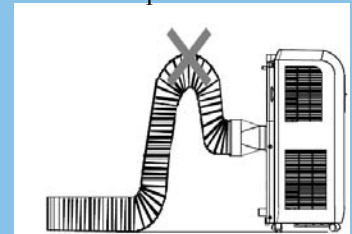

When installing the exhaust hose, try and keep it as flat as possible. The less angles and bends in the hose, the better the unit will perform. If bending or an angle is necessary, use single 90° angles like the pictures above. Multiple bends will decrease performance and efficiency

CONTROL PANEL, DISPLAY, & OPERATING INSTRUCTIONS

CONTROL PANEL & LED DISPLAY

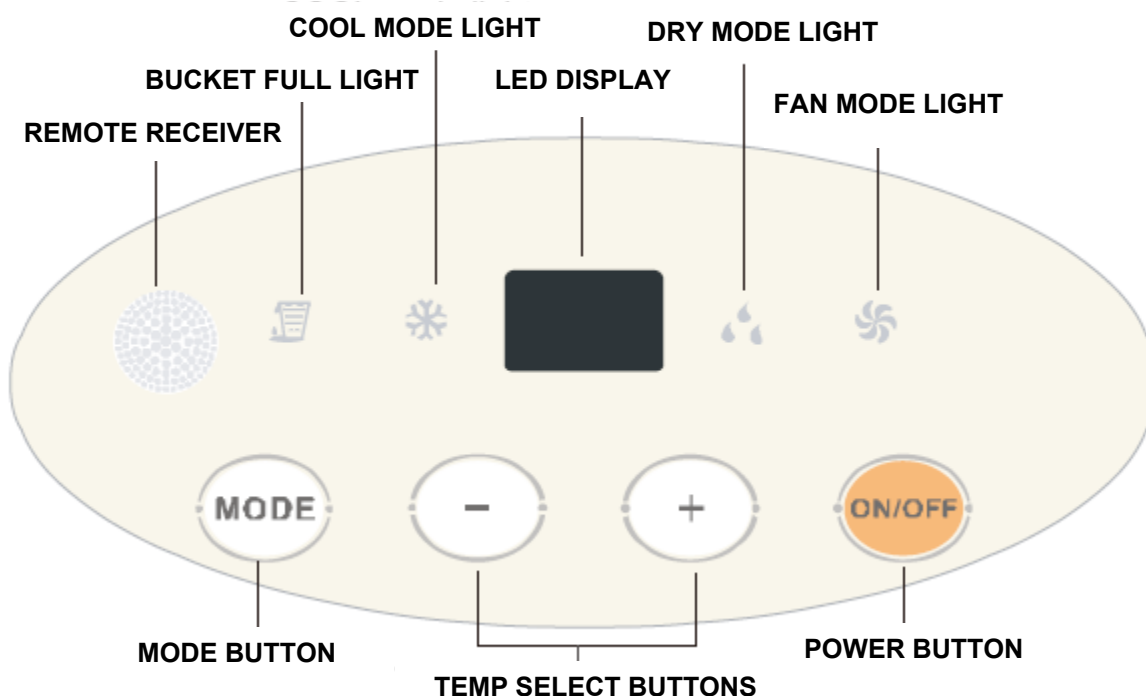

CONTROL PANEL OPERATING INSTRUCTIONS

- 1) **Power On and Off** - Press the **POWER** button once to manually turn the unit on. Press the **POWER** button once more to turn the unit off.
- 2) **Mode Selection** - Press the **MODE** Button repeatedly to cycle between the different modes: Air Conditioner, Dehumidifier, and Fan only mode. Each press of the **MODE** button will light up a different icon on the control panel. The exhaust hose and window kit must be installed when the unit is in Air Conditioner or Dehumidifier mode. When using the unit as a fan, it is not necessary to keep the exhaust hose and window kit connected to the unit.
- 3) **Temperature** - Select the desired temperature by pressing either - or + key when using the unit in cooling mode. The digital thermostat will display the set temperature.
- 4) **Louver Direction** - This unit has 4-Way directional louvers. Use the louver guides to direct air where cooling or fanning is needed most.
- 5) **Bucket Full** - When the unit cannot evaporate the collected moisture fast enough. The excess water will collect in a backup water tank located inside the unit. The bucket full icon will light up if this occurs

REMOTE CONTROL OPERATING INSTRUCTIONS

NOTE: Heat mode is not available on the SG-PAC-10E5 and KY-100E5

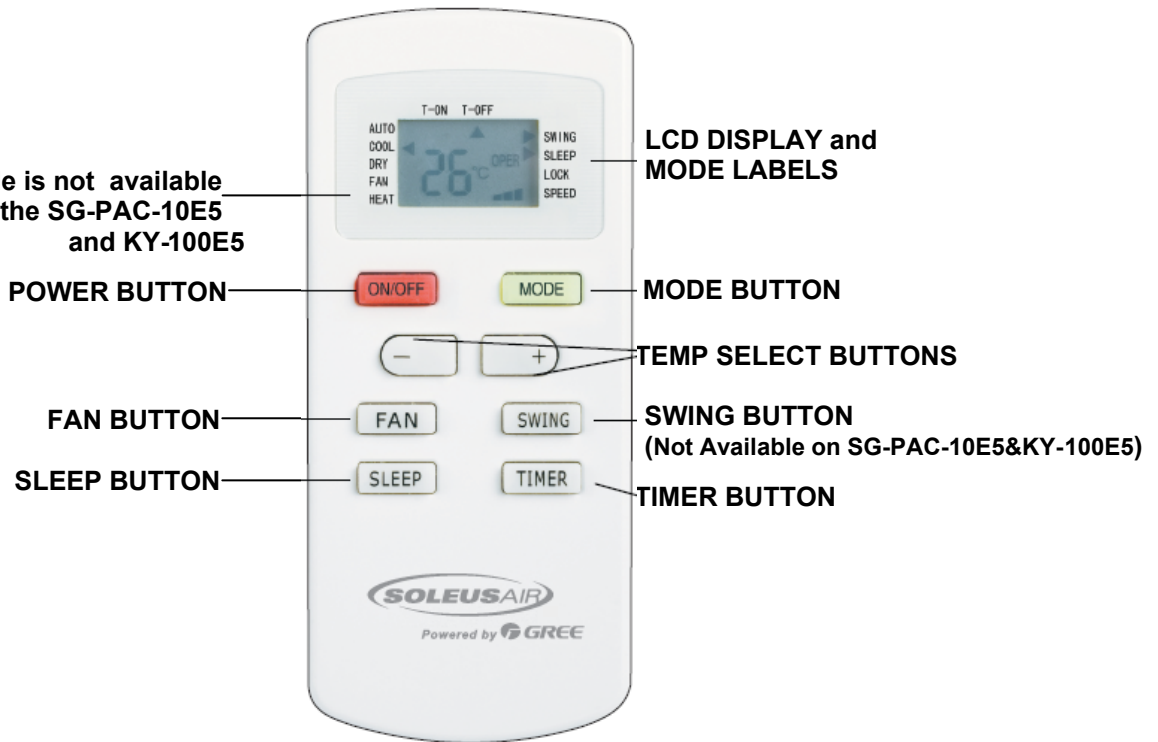

- 1) **Power On and Off** - Press the **ON/OFF (POWER)** button once to manually turn the unit on. Press the Power button once more to turn the unit off. When you manually power the unit on and off by pressing the **ON/OFF** button, the preset timer will be cancelled.
- 2) **Mode Selection** - Press the **MODE** Button repeatedly to cycle between the different modes: Auto, Air Conditioner, Dehumidifier, and Fan only mode. Once a mode is selected, an arrow will light up on the LCD display next to the selected **MODE** label on the remote. Auto mode automatically chooses the air conditioner, dehumidifier, or fan mode based on the current room temperature.

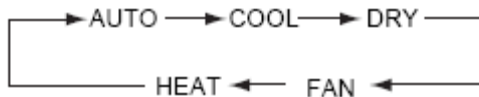

NOTE: HEAT MODE IS NOT AVAILABLE

- 3) **Fan Speed** - Press the **FAN** speed button to cycle through low, medium, and high fan speeds. The small fan icons will light up depending on which speed is selected. The more fan icons light up, the higher the speed. The fan icons are located on the LCD display next to the **SPEED** label.

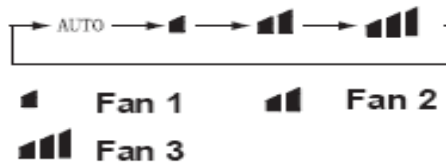

- 4) **Temperature Setting** - When the unit is in Air Conditioner mode you can select your desired temperature. Press the **TEMP SELECT** buttons (+ or -) to select your desired temperature setting. The temperature on the LCD display on the remote control will increase or decrease accordingly. Hold the +/- buttons for two seconds to rapidly increase or decrease the temperature.

REMOTE CONTROL OPERATING INSTRUCTIONS (Cont.)

5) **Auto-on Timer:** When the air conditioner is off, it can be set to automatically turn on in 30 minutes to 24 hours at the previous set mode and fan setting. To set the Auto-on Timer, press the **TIMER** button on the unit or remote control. Each touch of the +/- buttons on the remote will change the timer setting in 30 minute increments (.5 hours). The **T-ON** and **H** lights will blink while the Auto-on Timer is being set. Once the timer is set, press the **TIMER** button once more to save the setting. Press the **ON/OFF** button to cancel the timer.

Auto-off Timer: When the air conditioner is on, it can be set to automatically turn off in 30 minutes to 24 hours. To set the Auto-off Timer, press the **TIMER** button on the remote control. Each touch of the +/- buttons on the remote will change the timer setting in 30 minute (.5 hour) intervals. The **T-OFF** and **H** lights will blink while setting. To cancel the timer, press the **ON/OFF** button. Once the timer is set, press the **TIMER** button once more to save the setting. Press the **ON/OFF** button to cancel the timer.

6) **Sleep Mode** - Press the SLEEP mode button to engage SLEEP mode. Sleep mode automatically raises the set temperature by 2°F after one hour and 4°F after two hours. This feature limits compressor usage and enhances energy savings while you are sleeping.

7) **Auto Mode** - When AUTO mode is selected the air conditioner will automatically choose the operating mode base on the current room temperature. When the room is below 68°F the air conditioner will automatically fan the room to circulate air. When the room temperature is between 68°F-73°F the air conditioner will operate in Fan mode if it was previously selected or dehumidifier mode (if another mode was used previously) to remove humidity from the air as well as some cooling to help lower the room temperature. When the room temperature is between 74°F-79°F the air conditioner will always operate in dehumidifier mode. When the room temperature rises above 79°F, the unit will operate in air conditioner mode to maximize cooling. Auto mode uses pre-determined settings to keep you comfortable by choosing the most energy efficient mode based on the temperature of the room.

DRAINING COLLECTED WATER

When the temperature or humidity is too high, the air conditioner may not be able to evaporate all of the water as quickly as needed. All moisture that is unable to be evaporated is placed in a small bank up water tank inside the unit. When this tank is completely full, an alarm will sound, the compressor will shut off, and the bucket full icon will light up on the control panel. To manually empty the tank, please follow the instructions below.

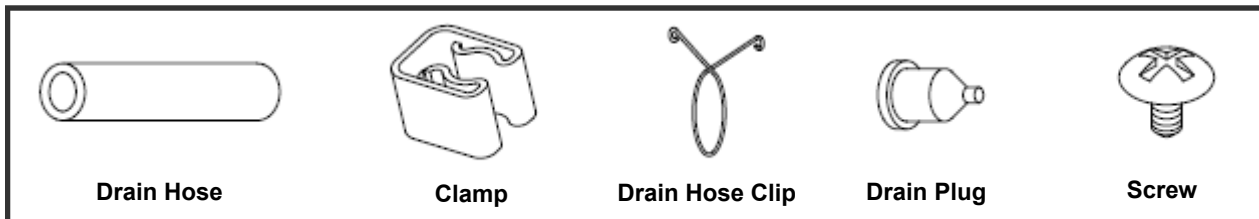

- 1) Remove the pre-installed Drain Cap from the unit (See Below).
- 2) Attach the Clamp with the provided Screw (See Below).

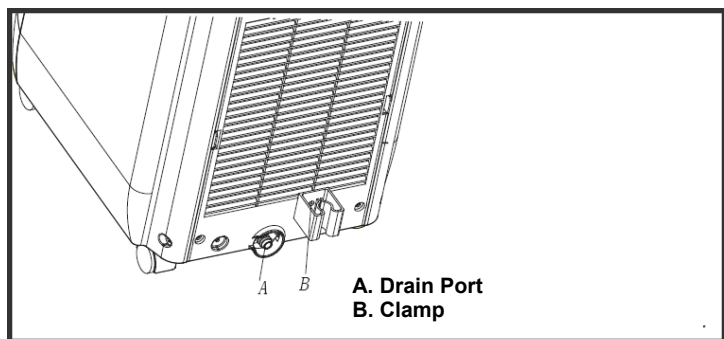
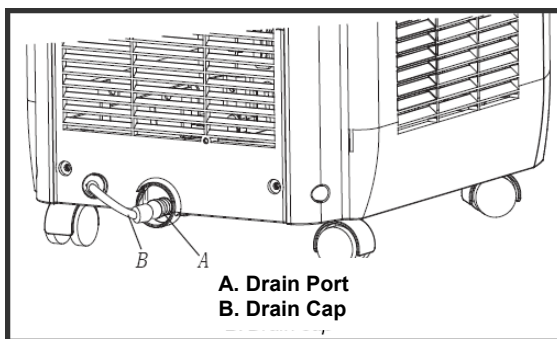

- 3) Attach the Drain Hose to the Drain Port using the Drain Hose Clip. Insert the Drain Plug into the free end of the Drain Hose and guide the Drain Hose through the Clamp. Once finished, the unit can be easily drained by removing the drain plug and guiding the drain hose into a small pan to drain the water.

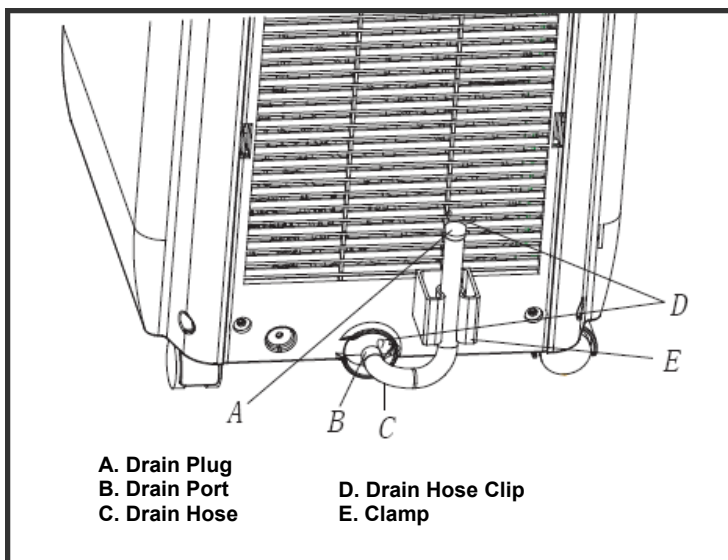

MAINTENANCE

Note: Make sure power is off and the power cord is not plugged into an electrical outlet prior to performing any maintenance on the unit.

Clean or replace filter - If the air filter is blocked with a dust, the airflow volume may reduce. It is recommended to clean the filter once every two weeks or as needed.

- 1) Remove the filter from the filter compartment on the back of the unit.
- 2) Wash the air filter by immersing it gently into warm water with a neutral detergent. Rinse the filter and dry it thoroughly out of sunlight.
- 3) Slide the filter back into the filter compartment after it is thoroughly dried.
- 4) If the filter is torn or unusable, order a new filter by calling the customer service number on the warranty page of this manual.

Clean the unit Housing

- 1) Keep the unit from being exposed directly to the sun to prevent color fading.
- 2) Clean the surface with a damp cloth and dry it with a soft towel.

Storing the Unit for an Extended Period of Time or Transporting the unit

- 1) Empty any excess water by unplugging the water drainage stop in the back of the unit (located at the bottom).
- 2) Unplug the unit.
- 3) The unit should be stored in a cool dry place.

DISCLAIMER

ALL INFORMATION AND THE TECHNICAL SPECIFICATIONS PRESENTED IN THIS USER'S MANUAL ARE THE PRESENTATION OF THE MANUFACTURER. SOLEUS INTERNATIONAL HAS NOT CONDUCTED INDEPENDENT TEST TO THE INFORMATION AND THE SPECIFICATIONS PRESENTED HEREWITHIN.

TROUBLESHOOTING

PROBLEM	POSSIBLE CAUSES	SOLUTIONS
The Air Conditioner will not start	The air conditioner is unplugged or not connected well.	<ul style="list-style-type: none"> • Make sure the air conditioner plug is pushed completely into the outlet
	The fuse is blown/circuit breaker is tripped.	<ul style="list-style-type: none"> • Check the house fuse/circuit breaker box and replace the fuse or reset the breaker.
	Power Failure	<ul style="list-style-type: none"> • The unit will automatically re-start when power is restored. • There is a protective time delay (approx. 3 minutes) to prevent tripping of the compressor overload. For this reason, the unit may not start normal cooling for 3 minutes after it is turned back on.
	The current interrupter device is tripped.	<ul style="list-style-type: none"> • Press the RESET button located on the power cord plug. • If the RESET button will not stay engaged, discontinue use of the air conditioner and contact a qualified service technician.
The Air Conditioner does not cool as it should	Airflow is restricted	<ul style="list-style-type: none"> • Make sure there are no curtains, blinds, or furniture blocking the front of the air conditioner
	The temperature control may not be set correctly.	<ul style="list-style-type: none"> • Lower the set thermostat temperature
	The air filter is dirty	<ul style="list-style-type: none"> • Clean the filter. See the Cleaning and Care Section of the manual.
	The room may be too warm	<ul style="list-style-type: none"> • Please allow time for the room to cool down after turning on the air conditioner.
	Cold air is escaping	<ul style="list-style-type: none"> • Check for open furnace registers and cold air returns
	The Evaporator is frozen	<ul style="list-style-type: none"> • The unit is defrosting and will resume operation when done.
The Air Conditioner displays the Timer hours but does not work	Is the TIMER ON enabled?	<ul style="list-style-type: none"> • Cancel the TIMER or wait until the unit turns on.
The Remote Control is not working	The batteries are inserted incorrectly	<ul style="list-style-type: none"> • Check the position of the batteries.
	The batteries may be dead	<ul style="list-style-type: none"> • Replace the batteries

TROUBLESHOOTING (CONT.)

PROBLEM	POSSIBLE CAUSES	SOLUTIONS
The LCD Display is showing "E5"	Low Voltage Protection	<ul style="list-style-type: none">• Unplug for 10 minutes and then turn on the unit. If "E5" is still displayed, contact customer service.
The LCD Display is showing "H8"	The backup water tank is full	<ul style="list-style-type: none">• Drain the water tank• If the "H8" is still displayed after the water tank has been emptied, contact customer service.

WARRANTY

One Year Limited Warranty

Soleus International Inc. warrants the accompanying Soleus Air Powered by Gree Portable Air Conditioner to be free of defects in material and workmanship for the applications specified in its operation instruction for a period of ONE (1) year from the date of original retail purchase in the United States.

If the unit exhibits a defect in normal use, Soleus International Inc. will, at its option, either repair or replace it, free of charge within a reasonable time after the unit is returned during the warranty period.

As a condition to any warranty service obligation, the consumer must present this Warranty Certificate along with a copy of the original purchase invoice.

THIS WARRANTY DOES NOT COVER:

- Damage, accidental or otherwise, to the unit while in the possession of a consumer not caused by a defect in material or workmanship.
- Damage caused by consumer misuse, tampering, or failure to follow the care and special handling provisions in the instructions.
- Damage to the finish of the case, or other appearance parts caused by wear.
- Damage caused by repairs or alterations of the unit by anyone other than those authorized by Soleus International Inc.
- Freight and Insurance cost for the warranty service.

ALL WARRANTIES, INCLUDING ANY IMPLIED WARRANTY OF MERCHANTABILITY ARE LIMITED TO ONE-YEAR DURATION OF THIS EXPRESS LIMITED WARRANTY. **SOLEUS INTERNATIONAL INC.** DISCLAIMS ANY LIABILITY FOR CONSEQUENTIAL OR INCIDENTAL DAMAGES AND IN NO EVENT SHALL SOLEUS INTERNATIONAL INC'S LIABILITY EXCEED THE RETAIL VALUE OF THE UNIT FOR BREACH OF ANY WRITTEN OR IMPLIED WARRANTY WITH RESPECT TO THIS UNIT.

This warranty covers only new products purchased from our authorized dealers or retailers. It does not cover used, salvaged, or refurbished products.

As some states do not allow the limitation or exclusion of incidental or consequential damages, or do not allow limitation on implied warranties, the above limitations and exclusions may not apply to you. This warranty gives you specific legal rights, and you may also have other rights that vary from state to state.

For Technical Support & Warranty Service

Please Call (888) 876-5387

Or Write To:

Soleus International Inc.

20035 E. Walnut Dr. North

City of Industry, CA 91789 U.S.A.

www.soleusair.com